

© **CAN in Automation e. V.**

**CAN**open  
Performance Test

**CiA Technical Report 308**

**Version 1.0**

**Date: 1<sup>st</sup> December 2001**

## History

Date	Version	Changes
31 <sup>st</sup> Oct 2000	0.1	Initial revision as a Work Draft Proposal
1 <sup>st</sup> Dec 2001	1.0	Initial publishing as Technical Report

# Table of Contents

- 1 Tables ..... 1**
- 2 Figures ..... 1**
- 3 Scope ..... 2**
- 4 References ..... 3**
- 5 Abbreviations ..... 3**
- 6 Pre-definitions ..... 4**
- 7 System Characteristics ..... 5**
  - 7.1 Measuring reaction times ..... 5
  - 7.2 SYNC Reaction Time ..... 6
  - 7.3 Cycle Time Measurement ..... 7
- 8 Busload Generator ..... 9**
  - 8.1 Table Structure ..... 9
  - 8.2 Scenarios ..... 9
  - 8.3 Busload Generator Tables ..... 10

## 1 Tables

Table 1: Example for Transmission Timing.....	9
Table 2: Example Busload Generator Table.....	9
Table 3: Bus traffic categories .....	10
Table 4: Guarding at 1 MBit/s.....	10
Table 5: SDO at 1 MBit/s .....	10
Table 6: PDO at 1 MBit/s .....	11
Table 7: SYNC at 1 MBit/s .....	12
Table 8: Guarding at 800 kBit/s.....	12
Table 9: SDO at 800 kBit/s.....	12
Table 10: PDO at 800 kBit/s.....	13
Table 11: SYNC at 800 kBit/s.....	14
Table 12: Guarding at 500 kBit/s.....	14
Table 13: SDO at 500 kBit/s.....	14
Table 14: PDO at 500 kBit/s.....	15
Table 15: SYNC at 500 kBit/s.....	16
Table 16: Guarding at 250 kBit/s.....	16
Table 17: SDO at 250 kBit/s.....	16
Table 18: PDO at 250 kBit/s.....	17
Table 19: SYNC at 250 kBit/s.....	18
Table 20: Guarding at 125 kBit/s.....	18
Table 21: SDO at 125 kBit/s.....	18
Table 22: PDO at 125 kBit/s.....	19
Table 23: SYNC at 125 kBit/s.....	20
Table 24: Guarding at 50 kBit/s.....	20
Table 25: SDO at 50 kBit/s.....	20
Table 26: PDO at 50 kBit/s.....	21
Table 27: SYNC at 50 kBit/s.....	22
Table 28: Guarding at 20 kBit/s.....	22
Table 29: SDO at 20 kBit/s.....	22
Table 30: PDO at 20 kBit/s.....	23
Table 31: SYNC at 20 kBit/s.....	24
Table 32: Guarding at 10 kBit/s.....	24
Table 33: SDO at 10 kBit/s.....	24
Table 34: PDO at 10 kBit/s.....	25
Table 35: SYNC at 10 kBit/s.....	26

## 2 Figures

Figure 1: Definition of the time stamp.....	4
Figure 2: Reaction time measurement.....	5
Figure 3: PDO Turnaround Time.....	6
Figure 4: SYNC Reaction Time.....	6
Figure 5: SDO Response Time.....	6
Figure 6: Boot-upTime.....	7
Figure 7: Guard Response Time and Guard Cycle Time.....	7
Figure 8: Cycle time measurement.....	7
Figure 9: PDO Timer Event Cycle Time.....	8
Figure 10: Communication Cycle Period.....	8
Figure 11: Heartbeat Cycle Time.....	8

### 3 Scope

CANopen is a field-bus protocol used in many diverse applications: CANopen networks can be found not only in various industrial applications ranging from printing machines and robots to process controls, but also in ships, building automation, trains, trucks and even in coffee machines. CANopen is used for high accuracy drive synchronisation and for flight data recording. It is also in use in medical applications and has been chosen as the standard communication protocol for passenger information systems in public transport.

This variety of applications leads to totally different requirements in regard to CANopen performance. The critical real-time requirement of one application may be a short response time to synchronisation messages relating to a single process data object, whereas a different application may expect a node with many event driven process data objects to send these objects immediately after a certain input signal has changed. With drive synchronisation for instance, some applications need long time accuracy of the sync cycle and tolerate almost any jitter of a single sync message, and others require minimal jitter and tolerate long term drift.

Regarding most other bus systems it is fairly straight-forward to measure and publish communication performance figures for most node types. With CANopen this is not the case: the capability of CANopen to tailor the communication to the application needs makes it very difficult to determine valuable performance figures that are independent of the specific network set-up. For example, figures relating to reaction times not only depend on the processor used, but on the actual bus load, on the type of CAN controller being used, on the actual number and types of I/Os or drives connected, on the number and transmission types of the process data objects, on the guard or heartbeat cycle, and on many other settings and parameters in the object dictionary. Developing a CANopen node always involves a certain trade-off between performance and functionality. Therefore performance is a multi-dimensional value.

The goal of this performance specification is to name and define a set of CANopen communication performance figures that may be used to compare devices and implementations within a specific application environment. It is not the aim of this paper to define a standard performance measuring environment, as this would lead to implementations that perform fine in exactly this environment but disappoint under most other conditions.

However, in order to establish some comparable conditions, this specification defines a number of standard bus loads that may be used to simulate or enhance application environments.

This performance test specification is aimed both at CANopen device developers and at CANopen system integrators. It may help developers determine relative performance figures regarding two implementation variants, thus leading to better devices and it may help system integrators to ask the right questions, thus leading to better CANopen networks.

## 4 References

- /1/ CiA DS 301, CANopen - Communication Profile for Industrial Systems, v 4.01, June 2000
- /2/ ISO 11898, Road vehicles - Interchange of digital information - Controller area network (CAN) for high-speed communication, 1993

## 5 Abbreviations

CAN:

Controller Area Network is an internationally standardized serial bus system.

COB:

Communication Object. A unit of transportation in a CAN network. Data must be sent across a CAN Network inside a COB. A COB can contain at most 8 bytes of data.

COB-ID:

Each COB is uniquely identified in a CAN network by a number called the COB Identifier (COB-ID). The COB-ID determines the priority of that COB for the MAC sub-layer.

Remote COB:

A COB whose transmission can be requested by another device.

CSDO:

Client SDO.

DLC:

Data Length Code of a CAN message.

DUT:

Device under test

NMT:

Network Management. One of the service elements of the application layer in the CAN Reference Model. The NMT serves to configure, initialise and handle errors in a CAN network.

PDO:

Process Data Object.

RPDO:

Receive PDO.

SDO:

Service Data Object.

SSDO:

Server SDO.

SYNC:

Synchronisation Object.

TPDO:

Transmit PDO.

## 6 Pre-definitions

In this document, the end marker of a CAN telegram is used as the reference point for all measurements regarding the time difference between two telegrams. This allows for the measurement of message times via the CAN-Receive/Transmit interrupt.

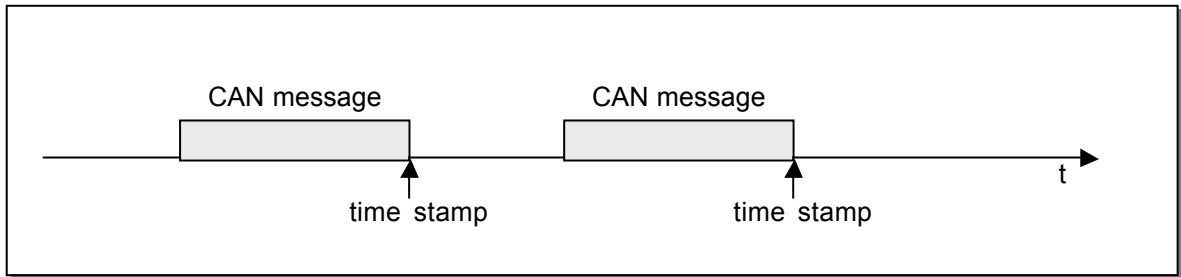

Figure 1: Definition of the time stamp

In the case that transmission start times are defined (see Chapter 8), this can only be done using internal timers, since it is not possible to precisely know when a message actually appears on the bus. Desired transmission start times can therefore only be defined as the time difference between two desired values. If a precise value is required for a transmission start time, this must be measured using the transmit interrupt following successful transmission.

## 7 System Characteristics

To attain results which are comparable it is necessary to define all relevant system characteristics and in doing so to give a unique definition of terms used. This document describes system characteristics which are not necessarily relevant for all device types, however in the case that they are relevant for a device, then the corresponding term must be used. Correspondingly it may be necessary to define additional characteristics which are device specific. The individual CANopen device profiles must cater for such device specific characteristics.

It is possible to classify system characteristics into two categories: reaction times and cyclic times.

### 7.1 Measuring reaction times

A reaction time measurement corresponds to the time difference between two CAN telegrams. A causal dependency must exist between the two telegrams, i.e. the initial frame causes the device under test (DUT) to itself react by transmitting a frame over the CAN bus. The time difference between the reception of the first frame and the reception of the second frame will be evaluated.

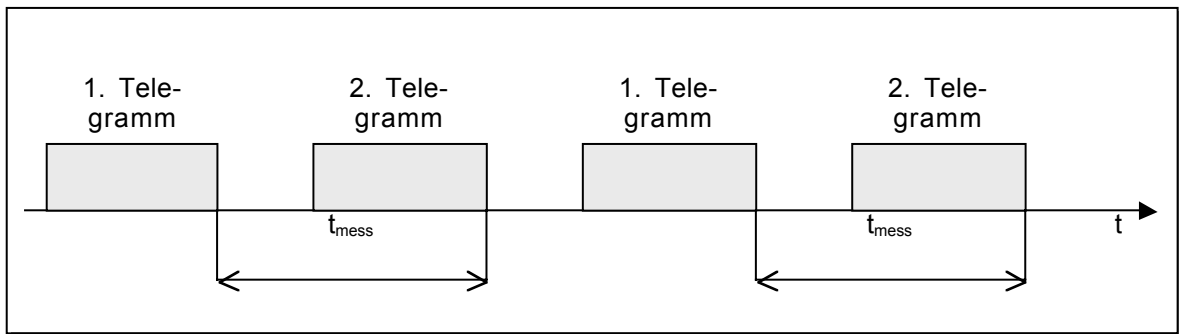

Figure 2: Reaction time measurement

For this measurement, the COB-ID and telegram type must be defined for both telegrams.

The first telegram which stimulates the DUT can be generated by the measurement tool or alternatively using another device.

#### 7.1.1 PDO Turnaround Time

The PDO Turnaround Time is defined as the time between the reception of a PDO telegram and the transmission of the corresponding "response" PDO (Figure 3).

Asynchronous PDOs will be transmitted only when a mapped object changes its value. Therefore, it is only possible to perform a time measurement by changing the value of an object linked to an RPDO.

Here for example, the application running on the DUT must copy an input value directly to an output or alternatively an input must be directly connected to an output. In this case an RPDO will be transmitted to the DUT and the corresponding object changed. This change will be recognised by the DUT and a TPDO with the new value will be transmitted by the DUT. The time between the two PDO's will be measured.

The measured time contains the time required by the DUT to read the received PDO and for the application to handle the received data. Also included is the time to prepare and transmit the PDO as well as the complete transmission time.



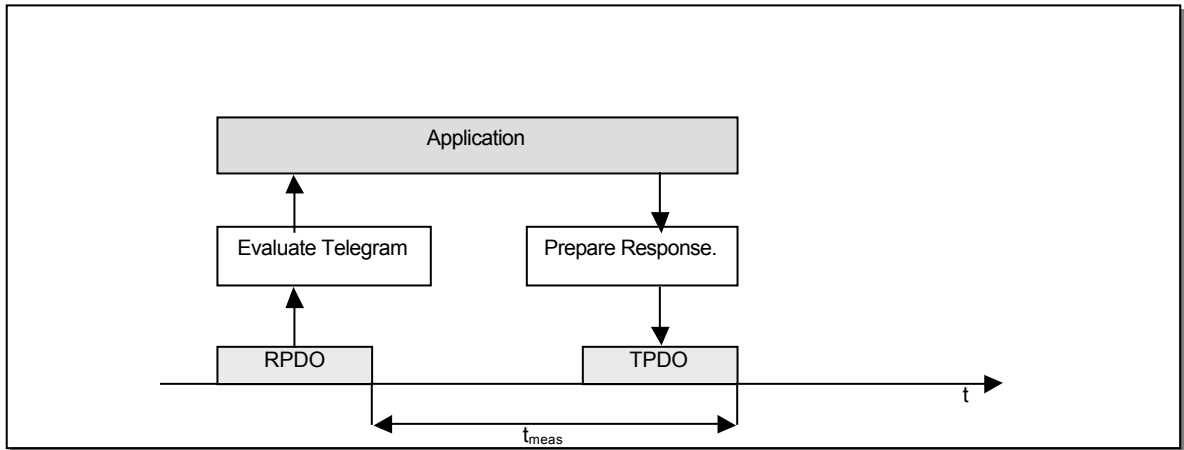

Figure 3: PDO Turnaround Time

### 7.2 SYNC Reaction Time

The SYNC Reaction Time is defined as the time between the reception of a SYNC telegram and the transmission of the "response" PDO (Figure 4).

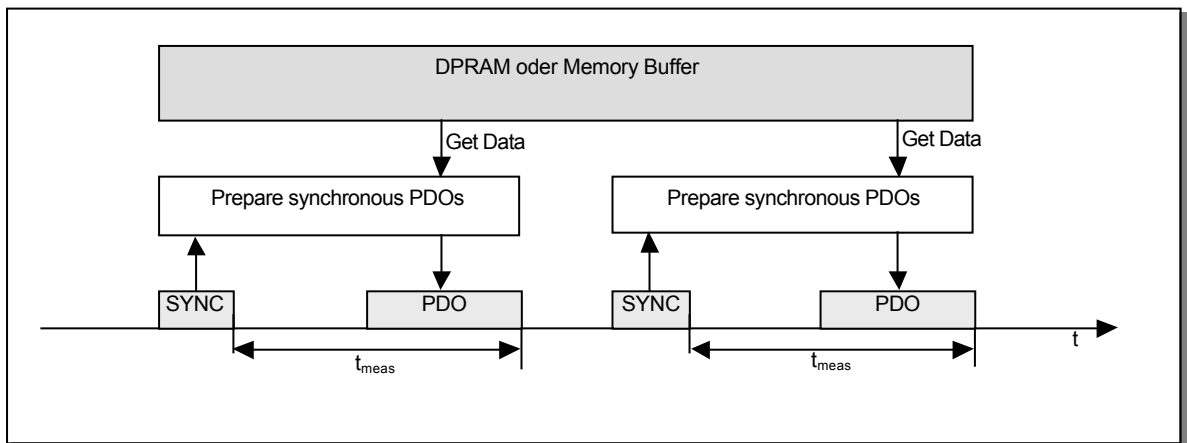

Figure 4: SYNC Reaction Time

#### 7.2.1 SDO Response Time

The SDO Response Time is defined as the time between the SDO request of a Client SDO and the SDO response of the Server SDO with expedited transfer (Figure 5).

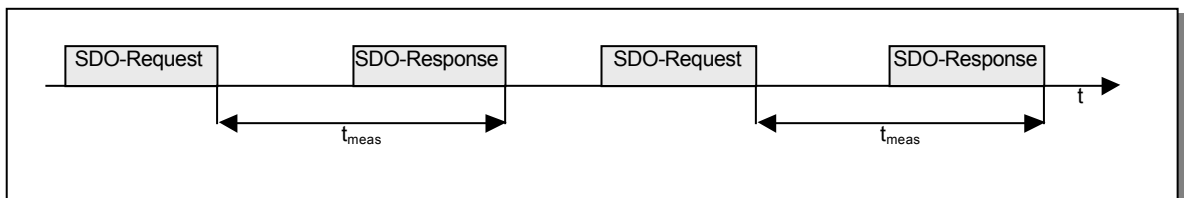

Figure 5: SDO Response Time

#### 7.2.2 Boot-up Time

In the case of the measurement of the Boot-up time, the time from an NMT Reset Node telegram until the transmission of the device Boot-Up telegram is measured (Figure 6). This value

provides information on the time required by the device to initialise its communication and device data.

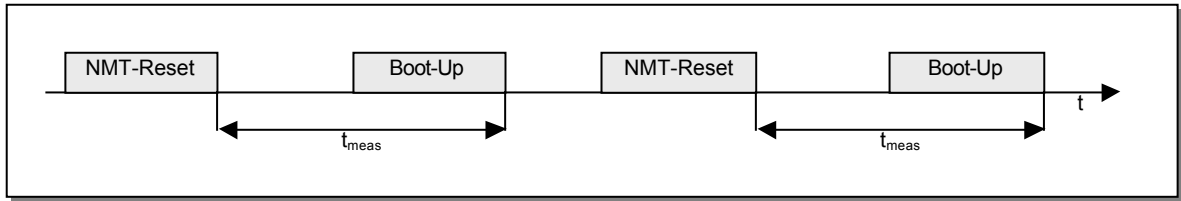

Figure 6: Boot-upTime

### 7.2.3 Guard Response Time and Guard Cycle Time

The Guard Response Time is defined as the time between a Guard Request (Remote Frame) and the corresponding Guard Response. The Guard Cycle Time is defined as the time between a Guard Request (Remote Frame) and the following Guard Request (Figure 7).

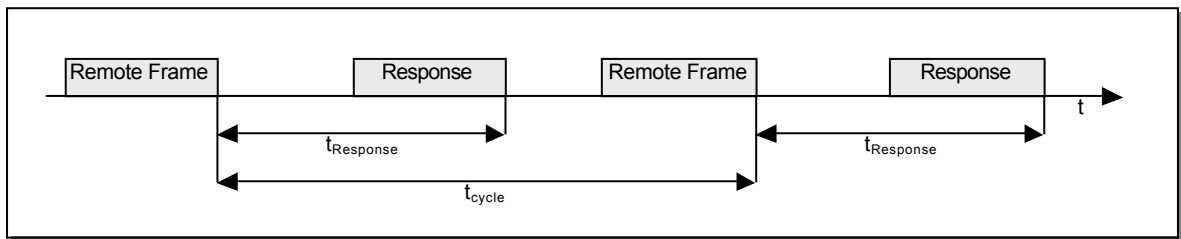

Figure 7: Guard Response Time and Guard Cycle Time

### 7.3 Cycle Time Measurement

In this case, the time between cyclical frames is measured.

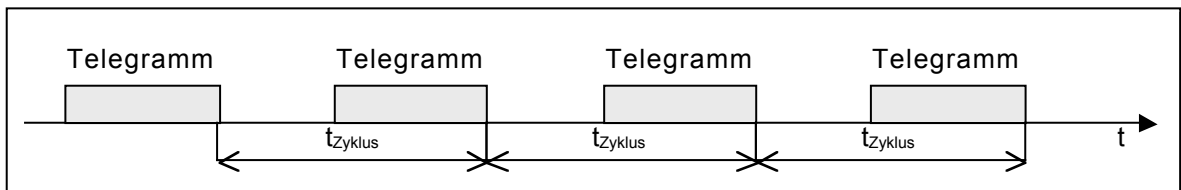

Figure 8: Cycle time measurement

It is worth noting that the required measurement accuracy depends very much on the specific application, for example

- in some cases the cycle time over a long period of time must be constant, whereas the time difference between individual cycles may vary
- in other cases the accuracy between consecutive cycles is relevant and not the accuracy over a long measurement period.

As quality measurements the standard deviation and the maximum deviation can be measured.

### 7.3.1 PDO Timer Event Cycle Time

The PDO Timer Event Cycle Time is the time between consecutive PDO's generated by a timer event. In this case the cyclical accuracy of a PDO with transmission type 254/255 (event driven) and of the corresponding timer event is measured (Figure 9).

It is important to note that the value of the object to be transmitted via PDO must not be allowed to change its value, since otherwise additional PDO's will be generated, thereby falsifying the measurement taken.

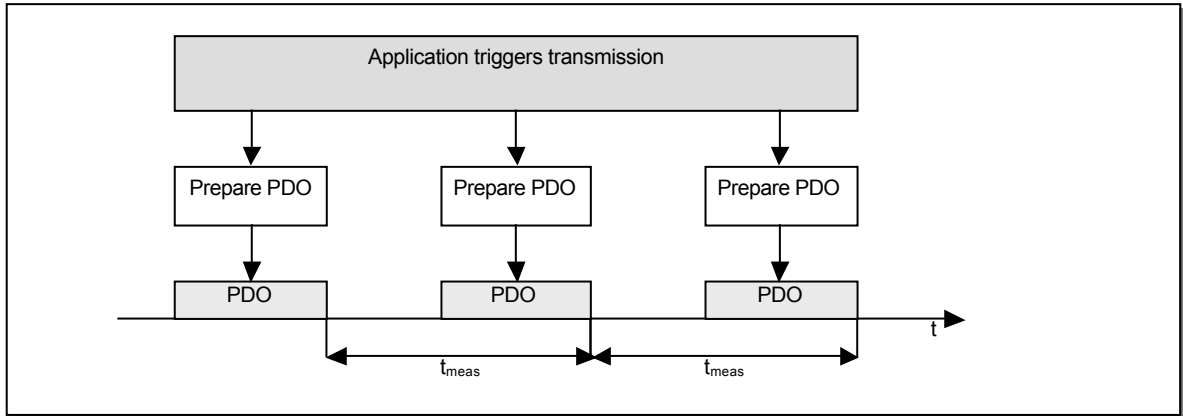

Figure 9: PDO Timer Event Cycle Time

### 7.3.2 Communication Cycle Period

The communication cycle period is defined in /1/ CiA DS 301. (See Figure 10)

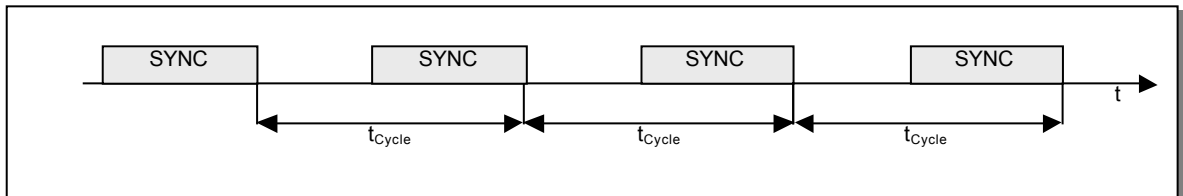

Figure 10: Communication Cycle Period

### 7.3.3 Guard Cycle Time

The Guard Cycle Time is the cyclical accuracy with which an NMT Master transmits the remote frames to each NMT Slave. (Figure 7).

### 7.3.4 Heartbeat Cycle Time

The Heartbeat Cycle Time is the cyclical accuracy with which a Heartbeat Producer transmits the heart beat telegram (Figure 11).

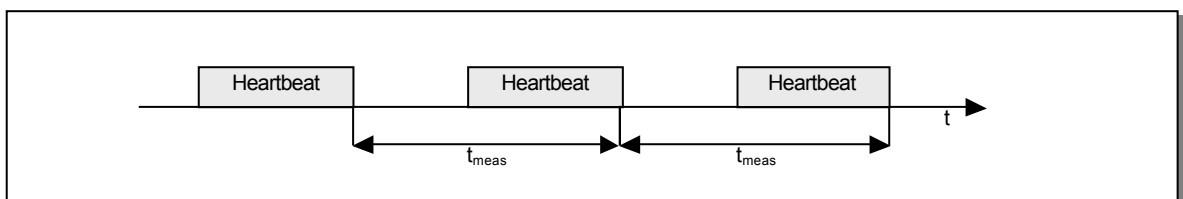

Figure 11: Heartbeat Cycle Time

## 8 Busload Generator

In order to produce reproducible measurement values under realistic conditions it is necessary to define and produce baud rate dependent background bus loads. This document defines bus loads for various baud rates.

### 8.1 Table Structure

The tables used to produce the bus load are row orientated. Each row contains a CAN telegram to be transmitted (see example in Table 2).

The start transmission time is calculated as an absolute value relative to the initial measurement begin time and is given in seconds. As defined in chapter 6 this is a calculated value for the time of the corresponding transmission request. If the previous message has not yet been transmitted, the message is entered into the CAN-controller as soon as it is available, therefore time differences of 0 can appear in the tables. Time delays resulting in this way or for example through bus arbitration with other transmitters correspond to the normal situation and are therefore acceptable. Once the last element of a table has been transmitted, transmission continues starting again at the beginning of the table. The time difference between the last telegram and the first telegram of the table is exactly the absolute value given for the first telegram.

In example Table 1 the first telegram is transmitted after 0.67636ms, the last telegram after 29.76ms. The transmission begins again with the first telegram at:

$$0.67636\text{ms} + 29.76\text{ms} = 30.43636\text{ms}$$

0.00067636	.....	.....	.....											
0.00135273	.....	.....	.....											
0.00202909	.....	.....	.....											
.....	.....	.....	.....											
0.02976000	.....	.....	.....											

Table 1: Example for Transmission Timing

The second table column contains the ID for the CAN channel and has always value 1. It allows for an extension to more than one channel at a later time.

The third table column contains the COB-ID to be transmitted.

Columns 4 and 5 contain further telegram attributes. Currently "Rx d" is used for a data frame and "Rx r" for Remote Frames.

Column 6 contains the DLC as a decimal value between 0 and 8.

The remaining columns contain the decimal data bytes. The number of columns is equal to the DLC value in column 6.

0.0006764	1	387	Rx	d	1	1								
0.0013527	1	643	Rx	d	2	2	3							
0.0020291	1	899	Rx	d	3	4	5	6						
0.0027055	1	392	Rx	d	4	7	8	9	10					

Table 2: Example Busload Generator Table

### 8.2 Scenarios

The background loads are defined as if they had been generated by devices with node id's 3, 5, 8, 12, 13, 32, 35, 43, 57 and 90 with the Pre-defined Connection Set. The DUT must have a different node id's. This allows testing without a reconfiguration of COB-IDs. If COB-ID's of

the DUT are changed, they must not collide with those of the Pre-defined connection set of the above node ID's.

The bus traffic consists of individual services according to table 3.

Category	Meaning
A	Guarding und Heartbeat
B	SDO Traffic
C	PDO
D	SYNC

Table 3: Bus traffic categories

These categories can be combined as required. Measurement reports can specify which categories were used.

A series of PDO's have variable data. These can be used in order to produce device internal load on the DUT. In this case corresponding RPDO's must be configured in the DUT.

Tables are given for all baud rates in order to produce comparable bus loads.

## 8.3 Busload Generator Tables

### 8.3.1 1 MBit/sec

0.0124	1	1795	Rx	r	0									
0.0124	1	1800	Rx	r	0									
0.0124	1	1804	Rx	r	0									
0.0125	1	1795	Rx	d	1	127								
0.0125	1	1800	Rx	d	1	127								
0.0125	1	1804	Rx	d	1	127								
0.0125	1	1805	Rx	d	1	127								
0.0125	1	1824	Rx	d	1	127								
0.0249	1	1883	Rx	r	0									
0.0249	1	1827	Rx	r	0									
0.0249	1	1835	Rx	r	0									
0.025	1	1883	Rx	d	1	127								
0.025	1	1827	Rx	d	1	127								
0.025	1	1835	Rx	d	1	127								
0.0374	1	1849	Rx	r	0									
0.0374	1	1882	Rx	r	0									
0.0374	1	1884	Rx	r	0									
0.0375	1	1849	Rx	d	1	127								
0.0375	1	1882	Rx	d	1	127								
0.0375	1	1884	Rx	d	1	127								
0.0499	1	1797	Rx	r	0									
0.0499	1	1807	Rx	d	1	127								

Table 4: Guarding at 1 MBit/s

0.015	1	1568	Rx	d	8	64	0	16	0	0	0	0	0	0
0.016	1	1440	Rx	d	8	67	0	16	0	0	0	0	0	0

Table 5: SDO at 1 MBit/s

0.000297	1	387	Rx	d	1	1							
0.000595	1	643	Rx	d	2	2	3						
0.000892	1	899	Rx	d	3	4	5	6					
0.001190	1	392	Rx	d	4	7	8	9	10				
0.001487	1	648	Rx	d	1	11							
0.001785	1	904	Rx	d	6	16	17	18	19	20	21		
0.002082	1	387	Rx	d	1	2							
0.002380	1	643	Rx	d	2	29	30						
0.002677	1	899	Rx	d	3	37	11	55					
0.002975	1	419	Rx	d	2	38	39						
0.003272	1	675	Rx	d	3	40	41	42					
0.003569	1	931	Rx	d	4	43	44	45	46				
0.003867	1	427	Rx	d	2	47	48						
0.004164	1	683	Rx	d	6	52	53	54	55	56	57		
0.004462	1	387	Rx	d	1	3							
0.004759	1	441	Rx	d	8	65	66	67	68	69	70	71	72
0.005057	1	697	Rx	d	1	73							
0.005354	1	953	Rx	d	2	74	75						
0.005652	1	474	Rx	d	1	76							
0.005949	1	730	Rx	d	4	79	80	81	82				
0.006247	1	643	Rx	d	2	29	30						
0.006544	1	527	Rx	d	8	0	0	0	0	0	0	0	0
0.006841	1	387	Rx	d	1	1							
0.007139	1	643	Rx	d	2	2	3						
0.007436	1	899	Rx	d	3	4	5	6					
0.007734	1	392	Rx	d	4	7	8	9	10				
0.008031	1	648	Rx	d	1	11							
0.008329	1	904	Rx	d	6	16	17	18	19	20	21		
0.008626	1	387	Rx	d	1	2							
0.008924	1	643	Rx	d	2	29	30						
0.009221	1	899	Rx	d	3	37	11	55					
0.009519	1	419	Rx	d	2	38	39						
0.009816	1	675	Rx	d	3	40	41	42					
0.010113	1	931	Rx	d	4	43	44	45	46				
0.010411	1	427	Rx	d	2	47	48						
0.010708	1	683	Rx	d	6	52	53	54	55	56	57		
0.011006	1	387	Rx	d	1	3							
0.011303	1	441	Rx	d	8	65	66	67	68	69	70	71	72
0.011601	1	697	Rx	d	1	73							
0.011898	1	953	Rx	d	2	74	75						
0.012196	1	474	Rx	d	1	76							
0.012493	1	730	Rx	d	4	79	80	81	82				
0.012791	1	643	Rx	d	2	29	30						
0.013088	1	527	Rx	d	8	255	255	255	255	255	255	255	255

Table 6: PDO at 1 MBit/s

0.01	1	128	Rx	d	0									
0.01	1	1155	Rx	d	1	255								
0.01	1	1160	Rx	d	2	254	253							
0.01	1	1164	Rx	d	3	252	251	250						
0.01	1	1187	Rx	d	4	249	248	247	246					
0.01	1	1195	Rx	d	4	245	244	243	242					
0.01	1	1209	Rx	d	1	240								
0.01	1	1242	Rx	d	1	234								

Table 7: SYNC at 1 MBit/s

**8.3.2 800 kBit/sec**

0.015525	1	1795	Rx	r	0									
0.015525	1	1800	Rx	r	0									
0.015525	1	1804	Rx	r	0									
0.015625	1	1795	Rx	d	1	127								
0.015625	1	1800	Rx	d	1	127								
0.015625	1	1804	Rx	d	1	127								
0.015625	1	1805	Rx	d	1	127								
0.015625	1	1824	Rx	d	1	127								
0.03115	1	1883	Rx	r	0									
0.03115	1	1827	Rx	r	0									
0.03115	1	1835	Rx	r	0									
0.03125	1	1883	Rx	d	1	127								
0.03125	1	1827	Rx	d	1	127								
0.03125	1	1835	Rx	d	1	127								
0.046775	1	1849	Rx	r	0									
0.046775	1	1882	Rx	r	0									
0.046775	1	1884	Rx	r	0									
0.046875	1	1849	Rx	d	1	127								
0.046875	1	1882	Rx	d	1	127								
0.046875	1	1884	Rx	d	1	127								
0.0624	1	1797	Rx	r	0									
0.0624	1	1807	Rx	d	1	127								

Table 8: Guarding at 800 kBit/s

0.01875	1	1568	Rx	d	8	64	0	16	0	0	0	0	0	0
0.02	1	1440	Rx	d	8	67	0	16	0	0	0	0	0	0

Table 9: SDO at 800 kBit/s

0.000372	1	387	Rx	d	1	1							
0.000744	1	643	Rx	d	2	2	3						
0.001115	1	899	Rx	d	3	4	5	6					
0.001487	1	392	Rx	d	4	7	8	9	10				
0.001859	1	648	Rx	d	1	11							
0.002231	1	904	Rx	d	6	16	17	18	19	20	21		
0.002603	1	387	Rx	d	1	2							
0.002975	1	643	Rx	d	2	29	30						
0.003346	1	899	Rx	d	3	37	11	55					
0.003718	1	419	Rx	d	2	38	39						
0.004090	1	675	Rx	d	3	40	41	42					
0.004462	1	931	Rx	d	4	43	44	45	46				
0.004834	1	427	Rx	d	2	47	48						
0.005205	1	683	Rx	d	6	52	53	54	55	56	57		
0.005577	1	387	Rx	d	1	3							
0.005949	1	441	Rx	d	8	65	66	67	68	69	70	71	72
0.006321	1	697	Rx	d	1	73							
0.006693	1	953	Rx	d	2	74	75						
0.007065	1	474	Rx	d	1	76							
0.007436	1	730	Rx	d	4	79	80	81	82				
0.007808	1	643	Rx	d	2	29	30						
0.008180	1	527	Rx	d	8	0	0	0	0	0	0	0	0
0.008552	1	387	Rx	d	1	1							
0.008924	1	643	Rx	d	2	2	3						
0.009295	1	899	Rx	d	3	4	5	6					
0.009667	1	392	Rx	d	4	7	8	9	10				
0.010039	1	648	Rx	d	1	11							
0.010411	1	904	Rx	d	6	16	17	18	19	20	21		
0.010783	1	387	Rx	d	1	2							
0.011155	1	643	Rx	d	2	29	30						
0.011526	1	899	Rx	d	3	37	11	55					
0.011898	1	419	Rx	d	2	38	39						
0.012270	1	675	Rx	d	3	40	41	42					
0.012642	1	931	Rx	d	4	43	44	45	46				
0.013014	1	427	Rx	d	2	47	48						
0.013385	1	683	Rx	d	6	52	53	54	55	56	57		
0.013757	1	387	Rx	d	1	3							
0.014129	1	441	Rx	d	8	65	66	67	68	69	70	71	72
0.014501	1	697	Rx	d	1	73							
0.014873	1	953	Rx	d	2	74	75						
0.015245	1	474	Rx	d	1	76							
0.015616	1	730	Rx	d	4	79	80	81	82				
0.015988	1	643	Rx	d	2	29	30						
0.016360	1	527	Rx	d	8	255	255	255	255	255	255	255	255

Table 10: PDO at 800 kBit/s



0.00625	1	128	Rx	d	0								
0.00625	1	1155	Rx	d	1	255							
0.00625	1	1160	Rx	d	2	254	253						
0.00625	1	1164	Rx	d	3	252	251	250					
0.00625	1	1187	Rx	d	4	249	248	247	246				
0.00625	1	1195	Rx	d	4	245	244	243	242				
0.00625	1	1209	Rx	d	1	240							
0.00625	1	1242	Rx	d	1	234							

Table 11: SYNC at 800 kBit/s

### 8.3.3 500 kBit/sec

0.0249	1	1795	Rx	r	0								
0.0249	1	1800	Rx	r	0								
0.0249	1	1804	Rx	r	0								
0.025	1	1795	Rx	d	1	127							
0.025	1	1800	Rx	d	1	127							
0.025	1	1804	Rx	d	1	127							
0.025	1	1805	Rx	d	1	127							
0.025	1	1824	Rx	d	1	127							
0.0499	1	1883	Rx	r	0								
0.0499	1	1827	Rx	r	0								
0.0499	1	1835	Rx	r	0								
0.05	1	1883	Rx	d	1	127							
0.05	1	1827	Rx	d	1	127							
0.05	1	1835	Rx	d	1	127							
0.0749	1	1849	Rx	r	0								
0.0749	1	1882	Rx	r	0								
0.0749	1	1884	Rx	r	0								
0.075	1	1849	Rx	d	1	127							
0.075	1	1882	Rx	d	1	127							
0.075	1	1884	Rx	d	1	127							
0.0999	1	1797	Rx	r	0								
0.0999	1	1807	Rx	d	1	127							

Table 12: Guarding at 500 kBit/s

	1	1568	Rx	d	8	64	0	16	0	0	0	0	0
0.032	1	1440	Rx	d	8	67	0	16	0	0	0	0	0

Table 13: SDO at 500 kBit/s

0.000595	1	387	Rx	d	1	1							
0.001190	1	643	Rx	d	2	2	3						
0.001785	1	899	Rx	d	3	4	5	6					
0.002380	1	392	Rx	d	4	7	8	9	10				
0.002975	1	648	Rx	d	1	11							
0.003569	1	904	Rx	d	6	16	17	18	19	20	21		
0.004164	1	387	Rx	d	1	2							
0.004759	1	643	Rx	d	2	29	30						
0.005354	1	899	Rx	d	3	37	11	55					
0.005949	1	419	Rx	d	2	38	39						
0.006544	1	675	Rx	d	3	40	41	42					
0.007139	1	931	Rx	d	4	43	44	45	46				
0.007734	1	427	Rx	d	2	47	48						
0.008329	1	683	Rx	d	6	52	53	54	55	56	57		
0.008924	1	387	Rx	d	1	3							
0.009519	1	441	Rx	d	8	65	66	67	68	69	70	71	72
0.010113	1	697	Rx	d	1	73							
0.010708	1	953	Rx	d	2	74	75						
0.011303	1	474	Rx	d	1	76							
0.011898	1	730	Rx	d	4	79	80	81	82				
0.012493	1	643	Rx	d	2	29	30						
0.013088	1	527	Rx	d	8	0	0	0	0	0	0	0	0
0.013683	1	387	Rx	d	1	1							
0.014278	1	643	Rx	d	2	2	3						
0.014873	1	899	Rx	d	3	4	5	6					
0.015468	1	392	Rx	d	4	7	8	9	10				
0.016063	1	648	Rx	d	1	11							
0.016657	1	904	Rx	d	6	16	17	18	19	20	21		
0.017252	1	387	Rx	d	1	2							
0.017847	1	643	Rx	d	2	29	30						
0.018442	1	899	Rx	d	3	37	11	55					
0.019037	1	419	Rx	d	2	38	39						
0.019632	1	675	Rx	d	3	40	41	42					
0.020227	1	931	Rx	d	4	43	44	45	46				
0.020822	1	427	Rx	d	2	47	48						
0.021417	1	683	Rx	d	6	52	53	54	55	56	57		
0.022012	1	387	Rx	d	1	3							
0.022607	1	441	Rx	d	8	65	66	67	68	69	70	71	72
0.023201	1	697	Rx	d	1	73							
0.023796	1	953	Rx	d	2	74	75						
0.024391	1	474	Rx	d	1	76							
0.024986	1	730	Rx	d	4	79	80	81	82				
0.025581	1	643	Rx	d	2	29	30						
0.026176	1	527	Rx	d	8	255	255	255	255	255	255	255	255

Table 14: PDO at 500 kBit/s

0.01	1	128	Rx	d	0								
0.01	1	1155	Rx	d	1	255							
0.01	1	1160	Rx	d	2	254	253						
0.01	1	1164	Rx	d	3	252	251	250					
0.01	1	1187	Rx	d	4	249	248	247	246				
0.01	1	1195	Rx	d	4	245	244	243	242				
0.01	1	1209	Rx	d	1	240							
0.01	1	1242	Rx	d	1	234							

Table 15: SYNC at 500 kBit/s

### 8.3.4 250 kBit/sec

0.0499	1	1795	Rx	r	0								
0.0499	1	1800	Rx	r	0								
0.0499	1	1804	Rx	r	0								
0.05	1	1795	Rx	d	1	127							
0.05	1	1800	Rx	d	1	127							
0.05	1	1804	Rx	d	1	127							
0.05	1	1805	Rx	d	1	127							
0.05	1	1824	Rx	d	1	127							
0.0999	1	1883	Rx	r	0								
0.0999	1	1827	Rx	r	0								
0.0999	1	1835	Rx	r	0								
0.1	1	1883	Rx	d	1	127							
0.1	1	1827	Rx	d	1	127							
0.1	1	1835	Rx	d	1	127							
0.1499	1	1849	Rx	r	0								
0.1499	1	1882	Rx	r	0								
0.1499	1	1884	Rx	r	0								
0.15	1	1849	Rx	d	1	127							
0.15	1	1882	Rx	d	1	127							
0.15	1	1884	Rx	d	1	127							
0.1999	1	1797	Rx	r	0								
0.1999	1	1807	Rx	d	1	127							

Table 16: Guarding at 250 kBit/s

0.06	1	1568	Rx	d	8	64	0	16	0	0	0	0	0
0.064	1	1440	Rx	d	8	67	0	16	0	0	0	0	0

Table 17: SDO at 250 kBit/s

0.001190	1	387	Rx	d	1	1							
0.002380	1	643	Rx	d	2	2	3						
0.003569	1	899	Rx	d	3	4	5	6					
0.004759	1	392	Rx	d	4	7	8	9	10				
0.005949	1	648	Rx	d	1	11							
0.007139	1	904	Rx	d	6	16	17	18	19	20	21		
0.008329	1	387	Rx	d	1	2							
0.009519	1	643	Rx	d	2	29	30						
0.010708	1	899	Rx	d	3	37	11	55					
0.011898	1	419	Rx	d	2	38	39						
0.013088	1	675	Rx	d	3	40	41	42					
0.014278	1	931	Rx	d	4	43	44	45	46				
0.015468	1	427	Rx	d	2	47	48						
0.016657	1	683	Rx	d	6	52	53	54	55	56	57		
0.017847	1	387	Rx	d	1	3							
0.019037	1	441	Rx	d	8	65	66	67	68	69	70	71	72
0.020227	1	697	Rx	d	1	73							
0.021417	1	953	Rx	d	2	74	75						
0.022607	1	474	Rx	d	1	76							
0.023796	1	730	Rx	d	4	79	80	81	82				
0.024986	1	643	Rx	d	2	29	30						
0.026176	1	527	Rx	d	8	0	0	0	0	0	0	0	0
0.027366	1	387	Rx	d	1	1							
0.028556	1	643	Rx	d	2	2	3						
0.029745	1	899	Rx	d	3	4	5	6					
0.030935	1	392	Rx	d	4	7	8	9	10				
0.032125	1	648	Rx	d	1	11							
0.033315	1	904	Rx	d	6	16	17	18	19	20	21		
0.034505	1	387	Rx	d	1	2							
0.035695	1	643	Rx	d	2	29	30						
0.036884	1	899	Rx	d	3	37	11	55					
0.038074	1	419	Rx	d	2	38	39						
0.039264	1	675	Rx	d	3	40	41	42					
0.040454	1	931	Rx	d	4	43	44	45	46				
0.041644	1	427	Rx	d	2	47	48						
0.042833	1	683	Rx	d	6	52	53	54	55	56	57		
0.044023	1	387	Rx	d	1	3							
0.045213	1	441	Rx	d	8	65	66	67	68	69	70	71	72
0.046403	1	697	Rx	d	1	73							
0.047593	1	953	Rx	d	2	74	75						
0.048783	1	474	Rx	d	1	76							
0.049972	1	730	Rx	d	4	79	80	81	82				
0.051162	1	643	Rx	d	2	29	30						
0.052352	1	527	Rx	d	8	255	255	255	255	255	255	255	255

Table 18: PDO at 250 kBit/s

0.02	1	128	Rx	d	0									
0.02	1	1155	Rx	d	1	255								
0.02	1	1160	Rx	d	2	254	253							
0.02	1	1164	Rx	d	3	252	251	250						
0.02	1	1187	Rx	d	4	249	248	247	246					
0.02	1	1195	Rx	d	4	245	244	243	242					
0.02	1	1209	Rx	d	1	240								
0.02	1	1242	Rx	d	1	234								

Table 19: SYNC at 250 kBit/s

### 8.3.5 125 kBit/sec

0.0999	1	1795	Rx	r	0									
0.0999	1	1800	Rx	r	0									
0.0999	1	1804	Rx	r	0									
0.1	1	1795	Rx	d	1	127								
0.1	1	1800	Rx	d	1	127								
0.1	1	1804	Rx	d	1	127								
0.1	1	1805	Rx	d	1	127								
0.1	1	1824	Rx	d	1	127								
0.1999	1	1883	Rx	r	0									
0.1999	1	1827	Rx	r	0									
0.1999	1	1835	Rx	r	0									
0.2	1	1883	Rx	d	1	127								
0.2	1	1827	Rx	d	1	127								
0.2	1	1835	Rx	d	1	127								
0.2999	1	1849	Rx	r	0									
0.2999	1	1882	Rx	r	0									
0.2999	1	1884	Rx	r	0									
0.3	1	1849	Rx	d	1	127								
0.3	1	1882	Rx	d	1	127								
0.3	1	1884	Rx	d	1	127								
0.3999	1	1797	Rx	r	0									
0.3999	1	1807	Rx	d	1	127								

Table 20: Guarding at 125 kBit/s

0.12	1	1568	Rx	d	8	64	0	16	0	0	0	0	0	0
0.128	1	1440	Rx	d	8	67	0	16	0	0	0	0	0	0

Table 21: SDO at 125 kBit/s

0.002380	1	387	Rx	d	1	1							
0.004759	1	643	Rx	d	2	2	3						
0.007139	1	899	Rx	d	3	4	5	6					
0.009519	1	392	Rx	d	4	7	8	9	10				
0.011898	1	648	Rx	d	1	11							
0.014278	1	904	Rx	d	6	16	17	18	19	20	21		
0.016657	1	387	Rx	d	1	2							
0.019037	1	643	Rx	d	2	29	30						
0.021417	1	899	Rx	d	3	37	11	55					
0.023796	1	419	Rx	d	2	38	39						
0.026176	1	675	Rx	d	3	40	41	42					
0.028556	1	931	Rx	d	4	43	44	45	46				
0.030935	1	427	Rx	d	2	47	48						
0.033315	1	683	Rx	d	6	52	53	54	55	56	57		
0.035695	1	387	Rx	d	1	3							
0.038074	1	441	Rx	d	8	65	66	67	68	69	70	71	72
0.040454	1	697	Rx	d	1	73							
0.042833	1	953	Rx	d	2	74	75						
0.045213	1	474	Rx	d	1	76							
0.047593	1	730	Rx	d	4	79	80	81	82				
0.049972	1	643	Rx	d	2	29	30						
0.052352	1	527	Rx	d	8	0	0	0	0	0	0	0	0
0.054732	1	387	Rx	d	1	1							
0.057111	1	643	Rx	d	2	2	3						
0.059491	1	899	Rx	d	3	4	5	6					
0.061871	1	392	Rx	d	4	7	8	9	10				
0.064250	1	648	Rx	d	1	11							
0.066630	1	904	Rx	d	6	16	17	18	19	20	21		
0.069009	1	387	Rx	d	1	2							
0.071389	1	643	Rx	d	2	29	30						
0.073769	1	899	Rx	d	3	37	11	55					
0.076148	1	419	Rx	d	2	38	39						
0.078528	1	675	Rx	d	3	40	41	42					
0.080908	1	931	Rx	d	4	43	44	45	46				
0.083287	1	427	Rx	d	2	47	48						
0.085667	1	683	Rx	d	6	52	53	54	55	56	57		
0.088047	1	387	Rx	d	1	3							
0.090426	1	441	Rx	d	8	65	66	67	68	69	70	71	72
0.092806	1	697	Rx	d	1	73							
0.095185	1	953	Rx	d	2	74	75						
0.097565	1	474	Rx	d	1	76							
0.099945	1	730	Rx	d	4	79	80	81	82				
0.102324	1	643	Rx	d	2	29	30						
0.104704	1	527	Rx	d	8	255	255	255	255	255	255	255	255

Table 22: PDO at 125 kBit/s

0.04	1	128	Rx	d	0									
0.04	1	1155	Rx	d	1	255								
0.04	1	1160	Rx	d	2	254	253							
0.04	1	1164	Rx	d	3	252	251	250						
0.04	1	1187	Rx	d	4	249	248	247	246					
0.04	1	1195	Rx	d	4	245	244	243	242					
0.04	1	1209	Rx	d	1	240								
0.04	1	1242	Rx	d	1	234								

Table 23: SYNC at 125 kBit/s

**8.3.6 50 kBit/sec**

0.2499	1	1795	Rx	r	0									
0.2499	1	1800	Rx	r	0									
0.2499	1	1804	Rx	r	0									
0.25	1	1795	Rx	d	1	127								
0.25	1	1800	Rx	d	1	127								
0.25	1	1804	Rx	d	1	127								
0.25	1	1805	Rx	d	1	127								
0.25	1	1824	Rx	d	1	127								
0.4999	1	1883	Rx	r	0									
0.4999	1	1827	Rx	r	0									
0.4999	1	1835	Rx	r	0									
0.5	1	1883	Rx	d	1	127								
0.5	1	1827	Rx	d	1	127								
0.5	1	1835	Rx	d	1	127								
0.7499	1	1849	Rx	r	0									
0.7499	1	1882	Rx	r	0									
0.7499	1	1884	Rx	r	0									
0.75	1	1849	Rx	d	1	127								
0.75	1	1882	Rx	d	1	127								
0.75	1	1884	Rx	d	1	127								
0.9999	1	1797	Rx	r	0									
0.9999	1	1807	Rx	d	1	127								

Table 24: Guarding at 50 kBit/s

0.3	1	1568	Rx	d	8	64	0	16	0	0	0	0	0	0
0.32	1	1440	Rx	d	8	67	0	16	0	0	0	0	0	0

Table 25: SDO at 50 kBit/s

0.005949	1	387	Rx	d	1	1							
0.011898	1	643	Rx	d	2	2	3						
0.017847	1	899	Rx	d	3	4	5	6					
0.023796	1	392	Rx	d	4	7	8	9	10				
0.029745	1	648	Rx	d	1	11							
0.035695	1	904	Rx	d	6	16	17	18	19	20	21		
0.041644	1	387	Rx	d	1	2							
0.047593	1	643	Rx	d	2	29	30						
0.053542	1	899	Rx	d	3	37	11	55					
0.059491	1	419	Rx	d	2	38	39						
0.065440	1	675	Rx	d	3	40	41	42					
0.071389	1	931	Rx	d	4	43	44	45	46				
0.077338	1	427	Rx	d	2	47	48						
0.083287	1	683	Rx	d	6	52	53	54	55	56	57		
0.089236	1	387	Rx	d	1	3							
0.095185	1	441	Rx	d	8	65	66	67	68	69	70	71	72
0.101135	1	697	Rx	d	1	73							
0.107084	1	953	Rx	d	2	74	75						
0.113033	1	474	Rx	d	1	76							
0.118982	1	730	Rx	d	4	79	80	81	82				
0.124931	1	643	Rx	d	2	29	30						
0.130880	1	527	Rx	d	8	0	0	0	0	0	0	0	0
0.136829	1	387	Rx	d	1	1							
0.142778	1	643	Rx	d	2	2	3						
0.148727	1	899	Rx	d	3	4	5	6					
0.154676	1	392	Rx	d	4	7	8	9	10				
0.160625	1	648	Rx	d	1	11							
0.166575	1	904	Rx	d	6	16	17	18	19	20	21		
0.172524	1	387	Rx	d	1	2							
0.178473	1	643	Rx	d	2	29	30						
0.184422	1	899	Rx	d	3	37	11	55					
0.190371	1	419	Rx	d	2	38	39						
0.196320	1	675	Rx	d	3	40	41	42					
0.202269	1	931	Rx	d	4	43	44	45	46				
0.208218	1	427	Rx	d	2	47	48						
0.214167	1	683	Rx	d	6	52	53	54	55	56	57		
0.220116	1	387	Rx	d	1	3							
0.226065	1	441	Rx	d	8	65	66	67	68	69	70	71	72
0.232015	1	697	Rx	d	1	73							
0.237964	1	953	Rx	d	2	74	75						
0.243913	1	474	Rx	d	1	76							
0.249862	1	730	Rx	d	4	79	80	81	82				
0.255811	1	643	Rx	d	2	29	30						
0.261760	1	527	Rx	d	8	255	255	255	255	255	255	255	255

Table 26: PDO at 50 kBit/s



0.1	1	128	Rx	d	0									
0.1	1	1155	Rx	d	1	255								
0.1	1	1160	Rx	d	2	254	253							
0.1	1	1164	Rx	d	3	252	251	250						
0.1	1	1187	Rx	d	4	249	248	247	246					
0.1	1	1195	Rx	d	4	245	244	243	242					
0.1	1	1209	Rx	d	1	240								
0.1	1	1242	Rx	d	1	234								

Table 27: SYNC at 50 kBit/s

**8.3.7 20 kBit/sec**

0.6249	1	1795	Rx	r	0									
0.6249	1	1800	Rx	r	0									
0.6249	1	1804	Rx	r	0									
0.625	1	1795	Rx	d	1	127								
0.625	1	1800	Rx	d	1	127								
0.625	1	1804	Rx	d	1	127								
0.625	1	1805	Rx	d	1	127								
0.625	1	1824	Rx	d	1	127								
1.2499	1	1883	Rx	r	0									
1.2499	1	1827	Rx	r	0									
1.2499	1	1835	Rx	r	0									
1.25	1	1883	Rx	d	1	127								
1.25	1	1827	Rx	d	1	127								
1.25	1	1835	Rx	d	1	127								
1.8749	1	1849	Rx	r	0									
1.8749	1	1882	Rx	r	0									
1.8749	1	1884	Rx	r	0									
1.875	1	1849	Rx	d	1	127								
1.875	1	1882	Rx	d	1	127								
1.875	1	1884	Rx	d	1	127								
2.4999	1	1797	Rx	r	0									
2.4999	1	1807	Rx	d	1	127								

Table 28: Guarding at 20 kBit/s

0.75	1	1568	Rx	d	8	64	0	16	0	0	0	0	0	0
0.8	1	1440	Rx	d	8	67	0	16	0	0	0	0	0	0

Table 29: SDO at 20 kBit/s

0.014873	1	387	Rx	d	1	1							
0.029745	1	643	Rx	d	2	2	3						
0.044618	1	899	Rx	d	3	4	5	6					
0.059491	1	392	Rx	d	4	7	8	9	10				
0.074364	1	648	Rx	d	1	11							
0.089236	1	904	Rx	d	6	16	17	18	19	20	21		
0.104109	1	387	Rx	d	1	2							
0.118982	1	643	Rx	d	2	29	30						
0.133855	1	899	Rx	d	3	37	11	55					
0.148727	1	419	Rx	d	2	38	39						
0.163600	1	675	Rx	d	3	40	41	42					
0.178473	1	931	Rx	d	4	43	44	45	46				
0.193345	1	427	Rx	d	2	47	48						
0.208218	1	683	Rx	d	6	52	53	54	55	56	57		
0.223091	1	387	Rx	d	1	3							
0.237964	1	441	Rx	d	8	65	66	67	68	69	70	71	72
0.252836	1	697	Rx	d	1	73							
0.267709	1	953	Rx	d	2	74	75						
0.282582	1	474	Rx	d	1	76							
0.297455	1	730	Rx	d	4	79	80	81	82				
0.312327	1	643	Rx	d	2	29	30						
0.327200	1	527	Rx	d	8	0	0	0	0	0	0	0	0
0.342073	1	387	Rx	d	1	1							
0.356945	1	643	Rx	d	2	2	3						
0.371818	1	899	Rx	d	3	4	5	6					
0.386691	1	392	Rx	d	4	7	8	9	10				
0.401564	1	648	Rx	d	1	11							
0.416436	1	904	Rx	d	6	16	17	18	19	20	21		
0.431309	1	387	Rx	d	1	2							
0.446182	1	643	Rx	d	2	29	30						
0.461055	1	899	Rx	d	3	37	11	55					
0.475927	1	419	Rx	d	2	38	39						
0.490800	1	675	Rx	d	3	40	41	42					
0.505673	1	931	Rx	d	4	43	44	45	46				
0.520545	1	427	Rx	d	2	47	48						
0.535418	1	683	Rx	d	6	52	53	54	55	56	57		
0.550291	1	387	Rx	d	1	3							
0.565164	1	441	Rx	d	8	65	66	67	68	69	70	71	72
0.580036	1	697	Rx	d	1	73							
0.594909	1	953	Rx	d	2	74	75						
0.609782	1	474	Rx	d	1	76							
0.624655	1	730	Rx	d	4	79	80	81	82				
0.639527	1	643	Rx	d	2	29	30						
0.654400	1	527	Rx	d	8	255	255	255	255	255	255	255	255

Table 30: PDO at 20 kBit/s

0.25	1	128	Rx	d	0									
0.25	1	1155	Rx	d	1	255								
0.25	1	1160	Rx	d	2	254	253							
0.25	1	1164	Rx	d	3	252	251	250						
0.25	1	1187	Rx	d	4	249	248	247	246					
0.25	1	1195	Rx	d	4	245	244	243	242					
0.25	1	1209	Rx	d	1	240								
0.25	1	1242	Rx	d	1	234								

Table 31: SYNC at 20 kBit/s

## 8.3.8 10 kBit/sec

1.2499	1	1795	Rx	r	0									
1.2499	1	1800	Rx	r	0									
1.2499	1	1804	Rx	r	0									
1.25	1	1795	Rx	d	1	127								
1.25	1	1800	Rx	d	1	127								
1.25	1	1804	Rx	d	1	127								
1.25	1	1805	Rx	d	1	127								
1.25	1	1824	Rx	d	1	127								
2.4999	1	1883	Rx	r	0									
2.4999	1	1827	Rx	r	0									
2.4999	1	1835	Rx	r	0									
2.5	1	1883	Rx	d	1	127								
2.5	1	1827	Rx	d	1	127								
2.5	1	1835	Rx	d	1	127								
3.7499	1	1849	Rx	r	0									
3.7499	1	1882	Rx	r	0									
3.7499	1	1884	Rx	r	0									
3.75	1	1849	Rx	d	1	127								
3.75	1	1882	Rx	d	1	127								
3.75	1	1884	Rx	d	1	127								
4.9999	1	1797	Rx	r	0									
4.9999	1	1807	Rx	d	1	127								

Table 32: Guarding at 10 kBit/s

1.5	1	1568	Rx	d	8	64	0	16	0	0	0	0	0	0
1.6	1	1440	Rx	d	8	67	0	16	0	0	0	0	0	0

Table 33: SDO at 10 kBit/s

0.029745	1	387	Rx	d	1	1							
0.059491	1	643	Rx	d	2	2	3						
0.089236	1	899	Rx	d	3	4	5	6					
0.118982	1	392	Rx	d	4	7	8	9	10				
0.148727	1	648	Rx	d	1	11							
0.178473	1	904	Rx	d	6	16	17	18	19	20	21		
0.208218	1	387	Rx	d	1	2							
0.237964	1	643	Rx	d	2	29	30						
0.267709	1	899	Rx	d	3	37	11	55					
0.297455	1	419	Rx	d	2	38	39						
0.327200	1	675	Rx	d	3	40	41	42					
0.356945	1	931	Rx	d	4	43	44	45	46				
0.386691	1	427	Rx	d	2	47	48						
0.416436	1	683	Rx	d	6	52	53	54	55	56	57		
0.446182	1	387	Rx	d	1	3							
0.475927	1	441	Rx	d	8	65	66	67	68	69	70	71	72
0.505673	1	697	Rx	d	1	73							
0.535418	1	953	Rx	d	2	74	75						
0.565164	1	474	Rx	d	1	76							
0.594909	1	730	Rx	d	4	79	80	81	82				
0.624655	1	643	Rx	d	2	29	30						
0.654400	1	527	Rx	d	8	0	0	0	0	0	0	0	0
0.684145	1	387	Rx	d	1	1							
0.713891	1	643	Rx	d	2	2	3						
0.743636	1	899	Rx	d	3	4	5	6					
0.773382	1	392	Rx	d	4	7	8	9	10				
0.803127	1	648	Rx	d	1	11							
0.832873	1	904	Rx	d	6	16	17	18	19	20	21		
0.862618	1	387	Rx	d	1	2							
0.892364	1	643	Rx	d	2	29	30						
0.922109	1	899	Rx	d	3	37	11	55					
0.951855	1	419	Rx	d	2	38	39						
0.981600	1	675	Rx	d	3	40	41	42					
1.011345	1	931	Rx	d	4	43	44	45	46				
1.041091	1	427	Rx	d	2	47	48						
1.070836	1	683	Rx	d	6	52	53	54	55	56	57		
1.100582	1	387	Rx	d	1	3							
1.130327	1	441	Rx	d	8	65	66	67	68	69	70	71	72
1.160073	1	697	Rx	d	1	73							
1.189818	1	953	Rx	d	2	74	75						
1.219564	1	474	Rx	d	1	76							
1.249309	1	730	Rx	d	4	79	80	81	82				
1.279055	1	643	Rx	d	2	29	30						
1.308800	1	527	Rx	d	8	255	255	255	255	255	255	255	255

Table 34: PDO at 10 kBit/s

0.5	1	128	Rx	d	0														
0.5	1	1155	Rx	d	1	255													
0.5	1	1160	Rx	d	2	254	253												
0.5	1	1164	Rx	d	3	252	251	250											
0.5	1	1187	Rx	d	4	249	248	247	246										
0.5	1	1195	Rx	d	4	245	244	243	242										
0.5	1	1209	Rx	d	1	240													
0.5	1	1242	Rx	d	1	234													

Table 35: SYNC at 10 kBit/s